

design — Chiara Andreatti



Hishi, 871/TBC
tavolino \ coffee table

La base in ceramica smaltata grigio sabbia e pesca, caratterizzata da un decoro a bassorilievo a maglia geometrica realizzato artigianalmente, che attraverso il deposito della cristallina crea ricercati effetti cromatici, contraddistingue la famiglia di tavolini Hishi. Proposti nelle due altezze, 47 cm e 55 cm, sono disponibili con piano tondo o quadrato in vetro bronzato.

The base in sand gray and peach ceramic, characterized by a handcrafted geometric-patterned bas-relief decoration, which through the deposit of the crystalline creates refined chromatic effects, distinguishes the Hishi coffee tables' family. Available in two heights, 47 cm and 55 cm, they are available with round or square top in bronzed glass.

Informazioni tecniche \ *Technical information*

Descrizione tecnica \ *Technical description*

Tavolino in due altezze. Base in ceramica con finitura lucida color pesca o grigio sabbia. Top tondo in vetro bronzato.

Coffee tables with two different heights. Ceramic base with peach or grey sand finish. Circular top in bronzed glass.

Dimensioni \ *Dimensions*

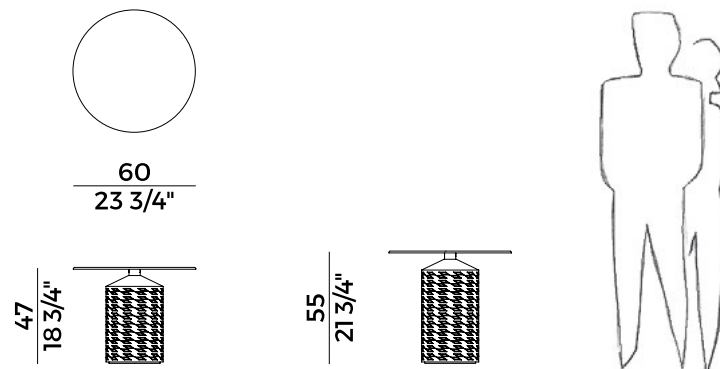

Finiture \ *Finishes*

Finiture struttura \ *Frame finishes*

Ceramica \ *Ceramic*

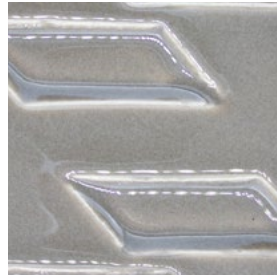

Grigio Sabbia \
Gray Sand



Pesca \
Peach

Finiture piano \ *Top finishes*

Vetro \ *Glass*



Vetro Bronzato \
Bronzed Glass

**Collezione Hishi **
Hishi collection

Collezione di tavolini in due altezze.
Base in ceramica con finitura lucida
color pesca o grigio sabbia. Top
quadrato o tondo in vetro bronzato.

*Collection of coffee tables with two
different heights. Ceramic base with
peach or grey sand finish. Square or
circular top in bronzed glass.*

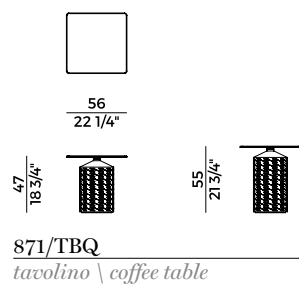
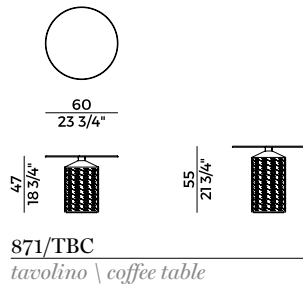



Hishi, 871/TBQ
tavolino \ coffee table

La base in ceramica smaltata grigio sabbia e pesca, caratterizzata da un decoro a bassorilievo a maglia geometrica realizzato artigianalmente, che attraverso il deposito della cristallina crea ricercati effetti cromatici, contraddistingue la famiglia di tavolini Hishi. Proposti nelle due altezze, 47 cm e 55 cm, sono disponibili con piano tondo o quadrato in vetro bronzato.

The base in sand gray and peach ceramic, characterized by a handcrafted geometric-patterned bas-relief decoration, which through the deposit of the crystalline creates refined chromatic effects, distinguishes the Hishi coffee tables' family. Available in two heights, 47 cm and 55 cm, they are available with round or square top in bronzed glass.

Informazioni tecniche \ *Technical information*

Descrizione tecnica \ *Technical description*

Tavolini in due altezze. Base in ceramica con finitura lucida color pesca o grigio sabbia. Top quadrato in vetro bronzato.

Coffee table with two different heights. Ceramic base with peach or grey sand finish. Square top in bronzed glass.

Dimensioni \ *Dimensions*

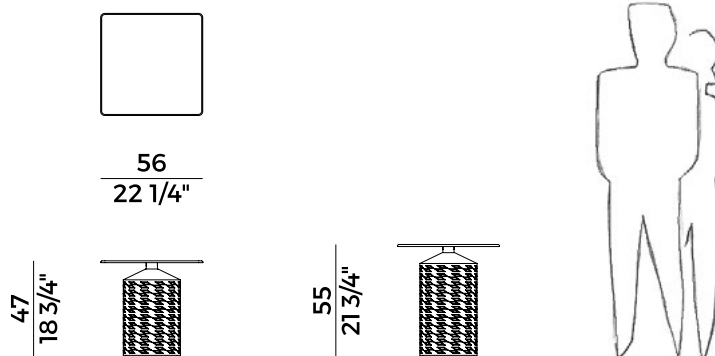

Finiture \ *Finishes*

Finiture struttura \ *Frame finishes*

Ceramica \ *Ceramic*



Grigio Sabbia \
Gray Sand



Pesca \
Peach

Finiture piano \ *Top finishes*

Vetro \ *Glass*



Vetro Bronzato \
Bronzed Glass

Collezione Hishi \

Hishi collection

Collezione di tavolini in due altezze.
Base in ceramica con finitura lucida
color pesca o grigio sabbia. Top
quadrato o tondo in vetro bronzato.

*Collection of coffee tables with two
different heights. Ceramic base with
peach or grey sand finish. Square or
circular top in bronzed glass.*

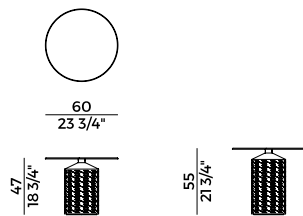

871/TBC

tavolino \ coffee table

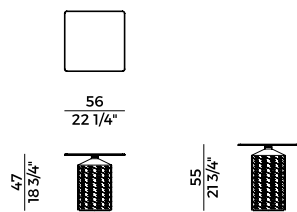

871/TBQ

tavolino \ coffee table